

PENSKE

≡≡≡ RACING SHOCKS. ≡≡≡



PS-8300-DA
Shock, Double-Adjustable Remote & Piggyback

TECHNICAL MANUAL

Main Office
150 Franklin St. • P.O. Box 1056
Reading, PA 19603
(610) 375-6180 • (610) 375-6190 Fax

Table of Contents:

Introduction	p.3
Terminology	p.4
Getting Started	p.5
Types of Adjusters	p.5
Types of Adjusters	p.6
Setting Adjusters	p.7
Factory Settings	p.8
Track Tuning	p.9
Troubleshooting	p.10
Parts List	p.11
Technical Support	p.13

Introduction

Thank you for your purchase of your new Penske Racing Shocks 8300 series double adjustable shocks!

The 8300 is our latest offering in two way adjustable configuration. This design has superseded our original 8100 design. As you will see in the following pages, major upgrades to performance and reliability have been added to make this the best two way adjustable shock on the market.

All of the fundamental attributes found in any Penske Racing Shock have been incorporated into the 8300 including:

- *Standard Penske 55mm bore size which allows use of wide array of piston types*
- *Low-friction shaft and piston seals*
- *Separate compression and rebound adjustment*
- *Hard anodized, 7000 series aluminum bodies and components for superior durability and performance*
- *Hard-chromed 4130 main shaft for strength, durability, and low breakaway friction*
- *Durable ACME thread body that allows quick adjustment of spring preload (.100" per turn)*
- *Winning heritage – Penske Racing Shocks continue to help our customers win races and championships in all forms of Motorsport.*
- *Made in U.S.A. – The 8300 has been 100% designed, machined, assembled, and tested for quality in the United States.*



Terminology:

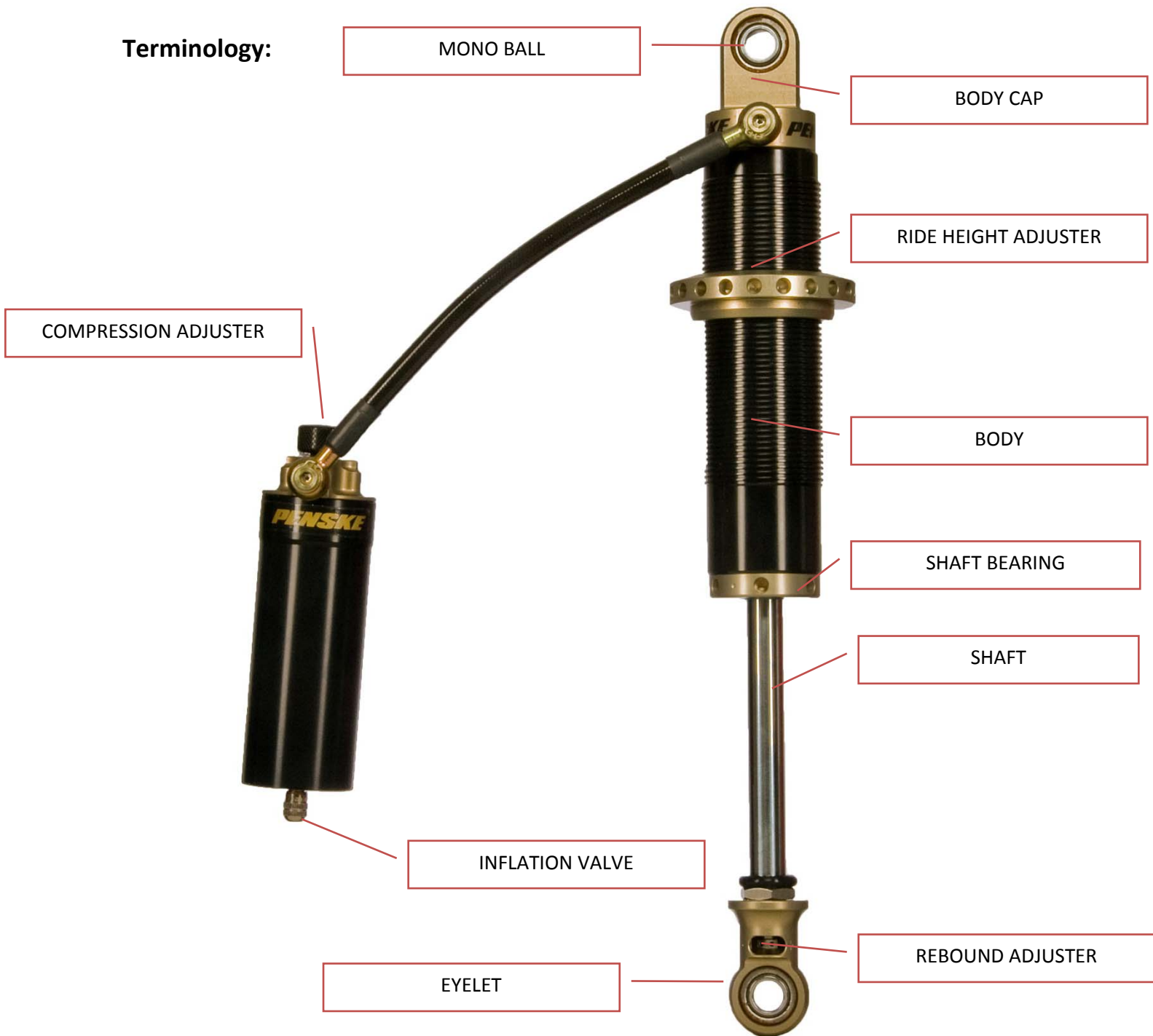

Getting Started:

The 8300 series shocks come set from the factory at a pre set adjuster setting ready to bolt on your vehicle. They dyno graph supplied will show you full adjustment range and where they are currently set. We will typically try and set the shocks at a mid setting so you can adjust them either stiffer or softer depending on your feel.

Adjusters:

Compression Adjuster- This is the knob that is located on the remote or piggy back canister. This will generally have 20-22 clicks of compression. If instead of a knob, you have a 1/2" hex head, you will have 20 clicks of compression adjustment. On your dyno sheet, you should see about 175lbs-200lbs of total compression adjustment. On both adjuster types, clockwise is stiffer, counter clockwise is softer.

Knob adjuster side entry/ 20-22 clicks

Hex adjuster top entry / 20 clicks of adjustment



116201_ST1300
 8983.mcr - FULL
 SOFT - 10.00
 in/sec
 FULL HARD - 10.00
 in/sec
 MID SETTINGS -
 10.00 in/sec

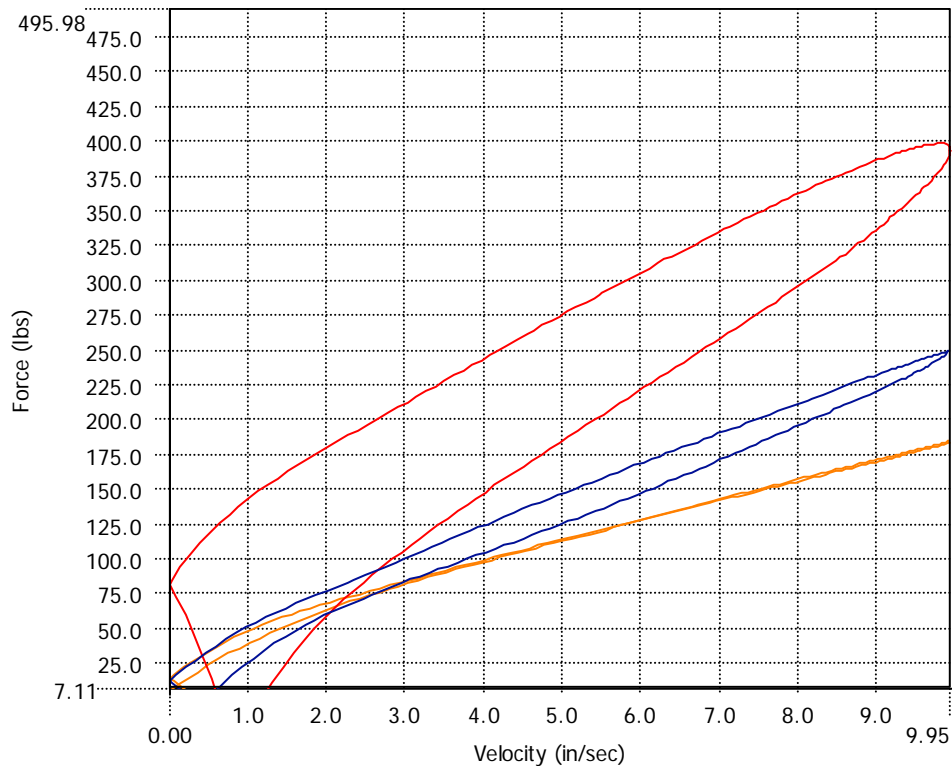

Rebound Adjuster- There are a couple different rebound adjustment knob options, all options have the adjuster mechanism on the eyelet end of the shock. Below are the different options and what they look like and the corresponding # of clicks.

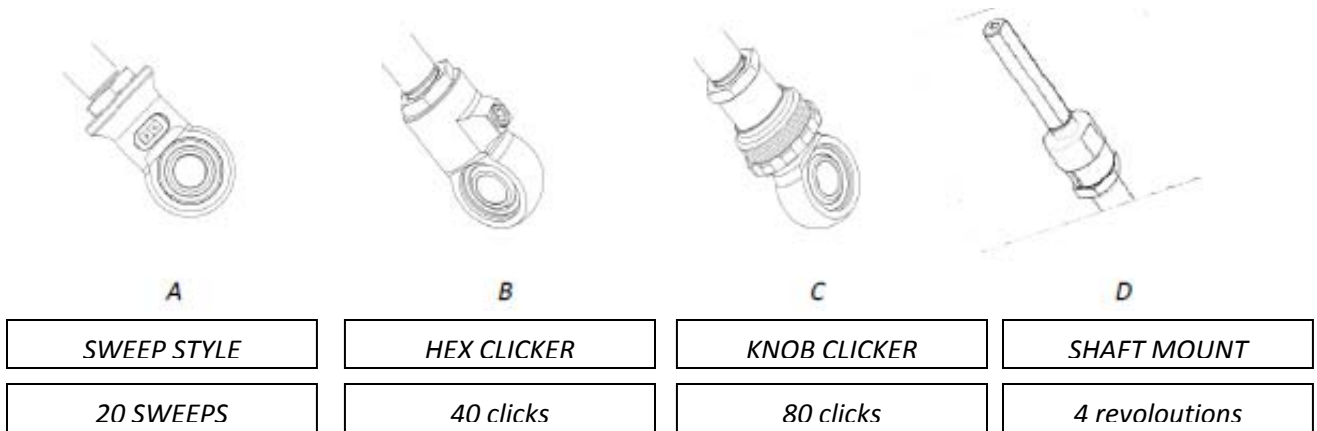

- A. **Sweep Style** adjuster is our standard eyelet configuration. 1 sweep means from one side of the window to the other side.
- B. **Hex Clicker** is an upgraded adjuster option. This eyelet requires the use of a 5/32 allen wrench to make adjustments
- C. **Knob Clicker** this eyelet is our most user friendly, no tools needed. The eyelet is self de-tented, so you have positive clicks when turned by hand
- D. **Shaft Mount** requires the use of a 3/32 "T-Handle" allen wrench. Detents can be added to this style adjuster for added cost. Typically this is a simple rotational type adjuster.

All rebound adjustment options will give you the same adjustment range. The increments may vary from adjuster to adjuster, but full hard and full soft ranges will be the same.

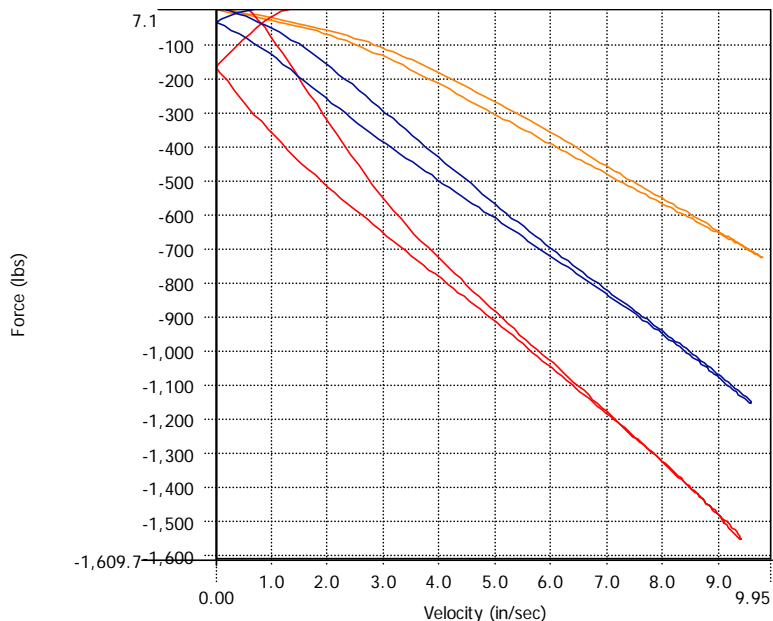

To Set Adjusters:

All of our adjusters work similar, in that “clockwise” is stiffer or more damping, “counter clockwise” is softer or less damping.

When you receive a dyno sheet, it will display your damping curve in full stiff, full soft, and shipped settings. You will notice the (-) before the setting; this identifies how many clicks **off of** full hard the adjuster was set to achieve this curve. Typically the graph will have a “C” for compression and “R” for rebound before the setting. If it doesn’t as an industry standard, compression is always referred to first, followed by rebound. So to set to specific setting, you would first wind adjuster to full hard, then count the number of clicks off of full hard until the desired setting is reached.

- LF comp -6, Reb -20.pvp
- Front comp -0, Reb -0.pvp
- Front comp -17, Reb -45.pvp

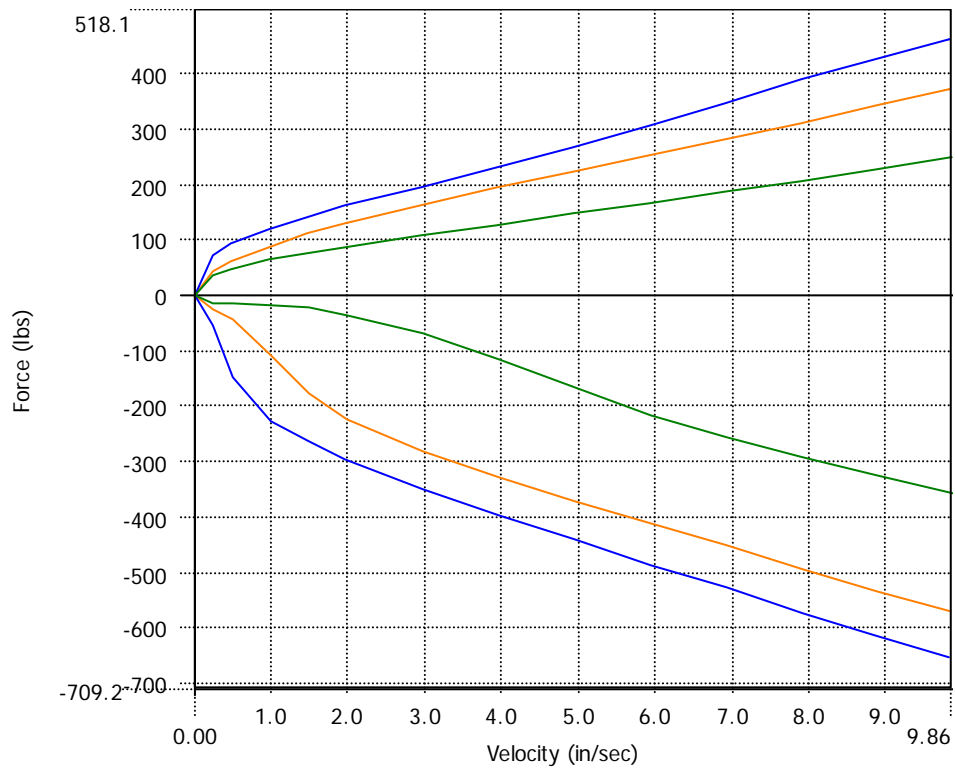

Factory Settings:

Adjusters:

- Typically from the factory we will set the adjusters in the “mid-range” of the damper. This may be different depending on specific set ups. It will be documented on your build sheet and dyno sheet what the start settings should be.
- Gas Pressure- This can vary depending on application. This could range from 50 psi to 200 psi depending on what type of vehicle or type of racing. Again this will be specified on your spec sheet and or dyno sheet.

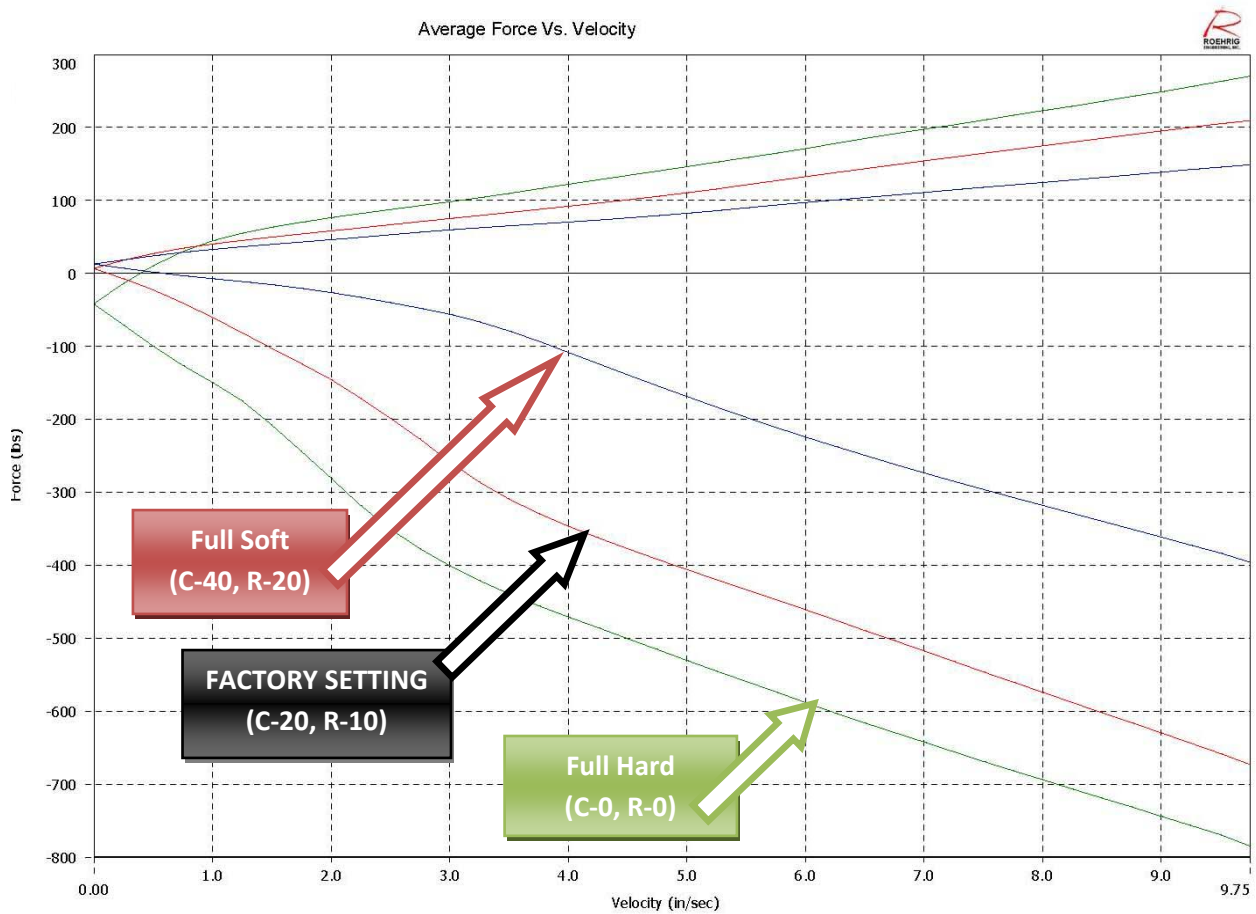

FACTORY SETTINGS:
COMPRESSION: =-20 / REBOUND: -10 SWEEPS

Track Tuning:

Compression Adjuster:

There are a number of different ways to tune a car, with either compression or rebound. Below are a few good starting points for compression.

1. Entry Under Steer/Push/Tight-

- a. This typically is a result of too much front compression. Soften compression -5 clicks. Soften the compression until you lose platform in the front of the car, or the front feels under supported, then go back +2 clicks.
- b. Soften rear rebound. Sometimes too much rear rebound will not allow weight to transfer to the front which can cause an under steer condition.

2. Entry Over Steer/Loose-

- a. Add rear rebound. You don't want to take grip away from the front if you don't have to. So first work on the end of the car with the grip issue, in this case is the rear. Stiffen rear rebound, if the rear is too soft, it will allow too much weight to transfer to the front too quickly. By slow this, you will keep more weight on the rear, generating more grip, longer into the corner.

3. Mid Entry Under Steer/Push/Tight-

- a. First try and determine if the chassis is taking a set, then going into under steer, or if it under steers before taking a set.
 - i. If it takes a set, then under steers, add compression to the front. This will support and slow the weight transfer just enough to eliminate or help the condition.
 - ii. If the chassis doesn't feel like it is taking a set, or feels like you not into the track, soften the compression, this will make the chassis more compliant, allow weight transfer a little quicker to the front tires and help increase grip.

4. Mid Entry Over Steer / Loose-

- a. Determine if it's off throttle or on throttle. If over steer is induced when getting back to throttle, soften rear rebound.
- b. If over steer is coming off throttle, add rear rebound.

5. Exit Under Steer:

- a. Add front rebound, try and hold weight on the front tires longer increasing grip.
- b. If it is still over steering, increase rear compression. This will balance out the chassis by taking some grip away from the rear.

6. Exit Over Steer:

- a. Reduce rear compression. This will allow quicker weight transfer to the rear tires, creating more grip.
- b. Reduce front rebound. This again will transfer more weight to the rear tires resulting in more grip.

Gas Pressure:

Gas pressure is like spring rate. This is more used for a fine tuning adjustment. 50psi is similar to 5-10lbs of spring rate. Adding more gas pressure is a common adjustment for qualifying, when you need to get your tires to max operating temp very quickly. If you do this, remember to reduce PSI before racing or shortened tire life may result.

Troubleshooting:**Signs of Fluid:**

If the area around the shaft bearing and shaft exhibits a small amount of moisture, this is normal. In order to reduce friction in the system, seal squeezes are slightly relaxed which serves the purpose to allow a small amount of fluid to be wicked onto the shaft when the strut operates. If you see excessive amount of fluid that may “pool” on the top of the shaft bearing, you may have a seal problem. Contact your Penske representative at once.

Loss of Gas Pressure:

If the strut for some reason loses its gas charge, the data may show that the velocity of that corner is much reduced. Also, a tell-tale sign of reduced or no gas pressure is that the strut (without a spring) when compressed, will not return to its fully extended position.

Failure of Shaft to Extend:

If the strut has lost pressure or lost excessive fluid, you may find that the strut shaft does not extend fully when compressed. In some situations, you may need to physically “pull” the shaft out in order for it to reach full extension.

Parts Diagram-

ITEM NO.	PART NO.	DESCRIPTION	ITEM NO.	PART NO.	DESCRIPTION
*	AS-76RESCAP	RESERVOIR CAP ASSEMBLY (ITEMS 27 - 33)	30	OR-2010-B	O-RING, 2-010 BUNA 70 DURO
*	AS-76SB	SHAFT BEARING ASSEMBLY (ITEMS 10 - 14)	31	IU-20-A	AIR VALVE, PORT O-RING, ALUM.
*	AS-83SIDE-BJ	HOUSING ASSEMBLY (ITEMS 34 - 50, 63 - 68)	32	IU-06	VALVE CAP, HIGH TEMPERATURE
1	RR-16	RETAINING RING, 1.025 SPIROLOC, STAINLESS	33	IU-04	VALVE CORE, 2000 PSI
2	MO-8T	MONOBALL, .500 ID X 1.00" OD	34	JT-83LS	JET, 8300 CD ADJUSTER
	MO-15T	MONOBALL, .15MM ID X 1.00" OD	35	OR-2012-B	O-RING, 2-012 BUNA 70 DURO
3	BC-830	BODYCAP, 8300 0	36	OR-2028-B	O-RING, 2-028 BUNA 70 DURO
	BC-8390	BODYCAP, 8300 90	37	OR-2013-B	O-RING, 2-013 BUNA 70 DURO
4	RH-83225	RIDE HEIGHT, 8300 2.25	38	SC-08	SCREW, SOCKET SET8/32 X 1/8
	RH-83250	RIDE HEIGHT, 8300 2.50	39	SP-14	SPRING, (A109)
5	BD-83	BODY, 8300 C/O 10" 24"ALUMINUM	40	BA-125-ST	BALL, 1/8" STEEL
6	SH-	SHAFT, ADJ 10" - 24"	41	KN- 83LS	KNOB, 8300 CD ADJUSTER
7	SR-81225	SPRING RETAINER, 8100 2.25	42	SC-83LS	SCREW, 8300 CD ADJUSTER
	SR-81250	SPRING RETAINER, 8100 2.50	43	OR-4MMX1MM-B	O-RING, 4 MM X1 MM BUNA
8	OR-2221-B	O-RING, 2-221 BUNA 70 DURO	44	VW-83CD	WASHER, 8300 CD ADJUSTER
9	SC-M6M8-S	SCREW, SHCS M6 X 8MM STEEL W/ NYLON	45	VW-01-C	CRUSH WASHER, 25 ID, COPPER
10	OR-2221-B	O-RING, 2-221 BUNA 70 DURO	46	OR-2222-B	O-RING, 2-222 BUNA 70 DURO
11	OR-2114-V	O-RING, 2-114 VITON 75 DURO	47	SC-06	SCREW, 1/2-20 X 3/4
12	SL-09	SHAFT WIPER, .625 POLY (BLUE)	48	VW-120012	WASHER, 1.200 X .012 X .500 VALVE
13	BU-10DU10	BUSHING, DU .625 X .625	49	VW-105012	WASHER, 1.050 X .012 X .500 VALVE
14	SB-765	SHAFT BEARING, 8760	50	VW-90012	WASHER, .900 X .012 X .500 VALVE
15	NE-76	NEEDLE, 8760	51	OR-2028-B	O-RING, 2-028 BUNA 70 DURO
16	OR-2007-B	O-RING, 2-007 BUNA 70 DURO	52	PI-55	PISTON BAND, .55MM
17	MR-ROD	METERING ROD	53	PI-	PISTON
18	NT-04J	JAM NUT, .625 X 18	54	NT-02R	RING NUT, .500 X 20, .440 LONG
19	RS-81	REBOUND SCREW, ADJ SHAFT	55	JT-RDHSNG	JET, RD STRAIGHT THRU
20	OR-2008-B	O-RING, 2-008 BUNA 70 DURO		JT-76RD	JET, REBOUND (ITEMS 55 - 59)
21	EY-81160	EYELET, 8100 1.60 SWEEP 0°	56	RR-05	RETAINING RING, .250 INTERNAL
	EY-81160NH	EYELET, 8100 1.60 SWEEP NO HOLE	57	JT-76HAT	JET, TOP HAT
	EY-811690	EYELET, 8100 1.60 SWEEP 90°	58	SP-15	SPRING, (FF71)
	EY-81200	EYELET, 8100 2.00 SWEEP 0°	59	JT-76POP	JET, POPPET
	EY-81230	EYELET, 8100 2.30 SWEEP 0°	60	VS-	VALVE STACK, (AA-F)
22	RB-76	RESERVOIR BODY, (4" - 7")	61	VW-99	TOP OUT PLATE, 1.375 X .500
23	PI-76	PISTON, 8760 RESERVOIR	62	VW-75020	WASHER, .750 X .020 X .500 VALVE
24	OR-4222-B	QUAD RING, 4-222 BUNA 70 DURO	63	PI-83CD	PISTON, 8300 CD ADJUSTER
25	SC-18	SCREW, SHCS 4-40 X1/4	64	HG-83SIDE	HOUSING, 8300 SIDE, BANJO
26	SL-87	SEAL, DOWTY	65	SC-91	SCREW, SOCKET SET 6-32 X .500"
27	OR-2222-B	O-RING, 2-222 BUNA 70 DURO	66	DO-06	DOWEL PIN, 1/16 X 3/8
28	RR-06	WIRE RING, .0625 WIRE DIAM. X 1.900	67	SP-10	SPRING, (TA2085)
29	CP-76	CAP, RESERVOIR PORT O-RING	68	BA-250-ST	BALL, 1/4" STEEL
			69	HO-83 -SW	HOSE, 8300 (6"-36"), SWIVEL HEAD

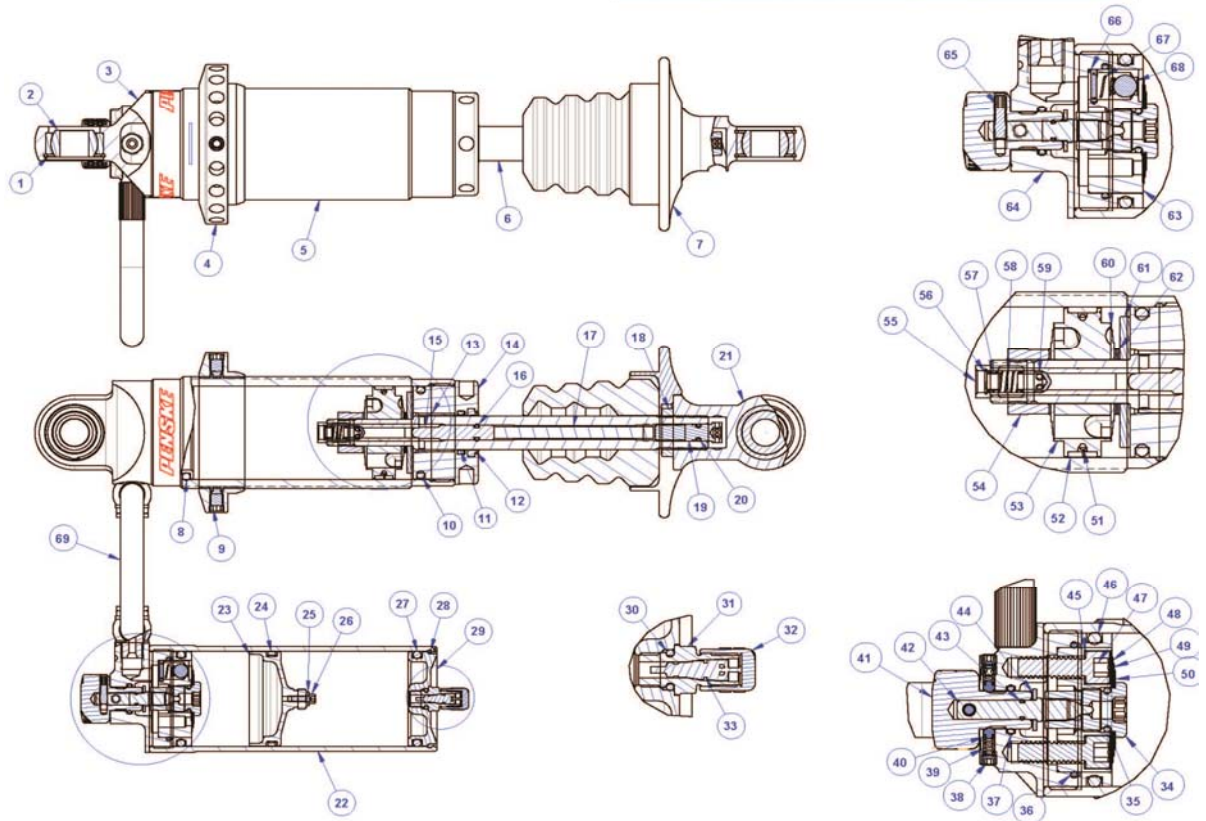

Technical Support:

8:30 AM – 5:00 PM (EST)

Penske Racing Shocks – Technical Center
150 Franklin Street
Reading, PA 19602
United States

610.375.6180

Penske Racing Shocks Midwest
12666 U.S. Route 12
Brooklyn, MI 49230
United States

517.592.6681

www.penskeshocks.com

